

# RSCDS Leeds Branch 60th Anniversary Ball

## 1 MAXWELL'S RANT R32 · 3/4L

David Rutherford: RSCDS XVIII 10 · Crib: E-cribs · Diagram: Keith Rose's Diagrams

- 1- Mirror Reels3 on the sidelines (1c cross down) (1x,2,3)
- 9- 1c cross back into mirror Reels3 on own sides
- 17- 1c cross RH | cast (2c up) ; ½ Fig8 round 2c
- 25- 1c dance down between 3c and cast up to 2pl ; 2c+1c+3c turn RH

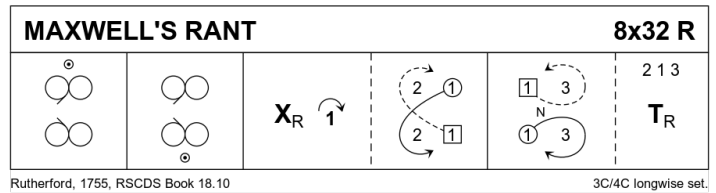

## 2 THE CHEQUERED COURT J32 · 3/4L

Duncan Brown: RSCDS XLII 3 · Crib: E-cribs · Diagram: Keith Rose's Diagrams

- 1- 1c cross RH | cast off (2c up) ; ½ Fig8 across to the R (1M up, 1W down) to face 1cnr
- 9- 1c+1cnrs pass and turn, at end 1c swivels R to be BtoB facing 4cnr ; 1c+4cnrs pass and turn, 1c swivels R to finish BtoB facing own side for DTr, 1c finish between end couple facing own side
- 17- DTr, 1c finish between end couple facing own side
- 25- Reels3{6} across (Rsh to 4cnr) | 1c cross RH (2,1,3)

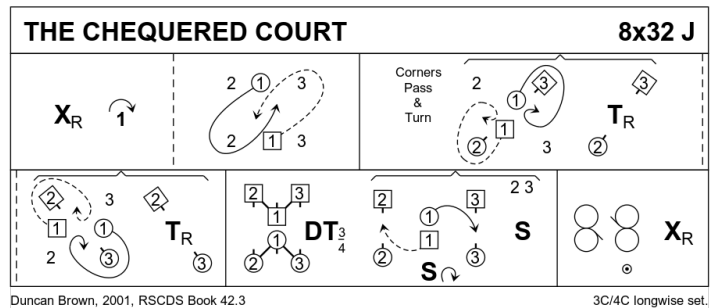

## 3 THE GARRY STRATHSPEY S32 · 4/4L

James B Cosh: Twenty Two SCD · Crib: E-cribs · Diagram: Keith Rose's Diagrams

- 1- 1c+2c & 3c+4c ½R&L ; 1c+4c ½R&L (2x,4,1,3x)
- 9- 2c+4c & 1c+3c ½circle4 L | 2c+3c ½circle4 R ; 1c lead to top (others step down) (to 1x,4x,3x,2x)
- 17- End couples facing middle couples All Set H.Schottische ; half G-Chain (2,3,4,1)
- 25- All Reels4 on own sides.

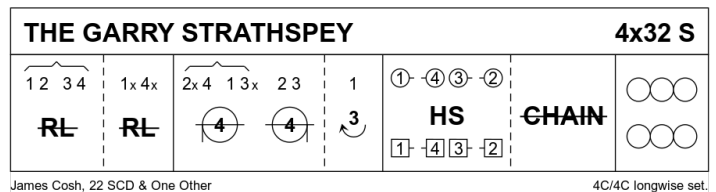

## 4 ALL THE EIGHTS J32 · 3/4L

Brenda Burnell: *The Leeds Golden Collection* · Crib: *SCDDB Contributed Cribes & Diagrams* · Diagram: *Keith Rose's Diagrams*

- 1-6 Reel of three on the sides, 1s crossing
- 7-8 1s dance down to face 3m, promenade hold, 2c dance to 1st place
- 9-16 1s dance R Sh reel of three with 2nd corners
- 17-24 1s dance L Sh reel of three with 1st corners
- 24-32 1s cross down between 3s, cast up to 2nd place, dance up between 2s, cast to 2nd place own sides

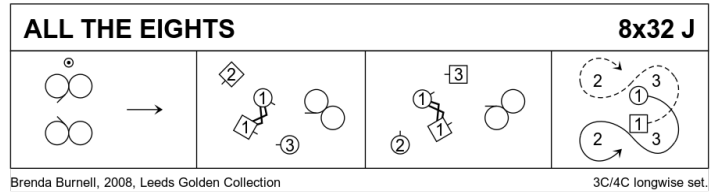

## 5 THE BLACK MOUNTAIN REEL R32 · 5/5L

Derek Haynes: *Thirty Popular Dances, Volume Two* · Crib: *E-cribs* · Diagram: *Keith Rose's Diagrams*

- 1- 1c & 3c cross RH | cast off (2c+4c up) ; ½ Fig8 up and face 1cnr
- 9- Turn CPCP (1c & 3c turn 1cnr RH, P LH, 2cnr RH, P LH), finish facing 1cnr
- 17- 1c & 3c Reels4 with 1cnrs, at the end pass P Lsh.
- 25- 1W+2c (top), 1M+4c+3W (middle) and 3M+5c (bottom) RHA ; 1c & 3c turn LH and cast off (4c+5c up). (to: 2,4,1,5,3)

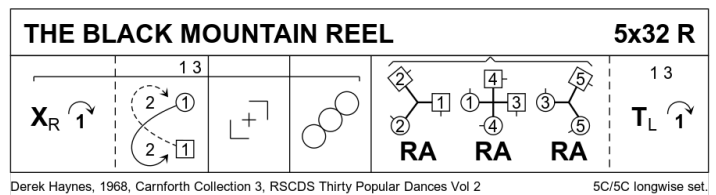

## 6 AN ILKLEY GIFT S32 · 3/4L

Roy Goldring: *Many Happy Hours - Pretoria 35th* · Crib: *E-cribs* · Diagram: *Keith Rose's Diagrams*

- 1-- All set | 1c dance down to 3pl and face out **while{2}** 2c & 3c dance up 1 place and face in ; 1c+3c change places EH 1½ (2,1,3)
- 9-- 1c with 3c following cross between 2c, cast off, cross up between 2c again, and cast off to (2,3,1)
- 17-- All set | 1c dance up to 1pl and face out **while{2}** 2c & 3c dance down 1 place and face in ; 1c+2c change places EH 1½, 2c facing out at end (2,1,3)
- 25-- Mirror Reels3 on sidelines, 1c cross up to start. On [29-30] 1c in 2plx cross down (2,1,3)

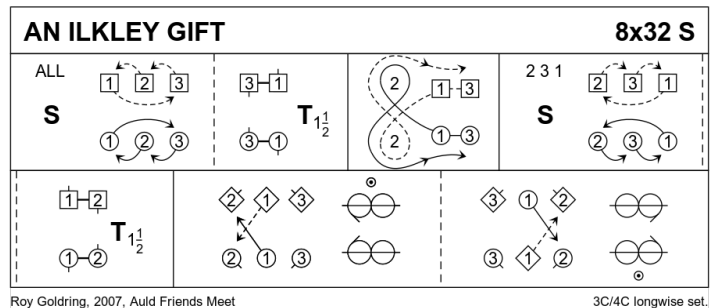

## 7 ANNIVERSARY REEL R32 · 4/4L

Sheila Muir: RSCDS XXXVI 7 · Crib: E-cribs · Diagram: Keith Rose's Diagrams

- 1-- 1c cross RH, cast off (2c up), ½ Fig8 up (2,1,3,4)
- 9-- 1W Reel3 across with 2c (Lsh to 2M) **while{8}** 1M ½ Lsh Reel3 with 3c then ½ Reel3 with 4c (Rsh to 4M)
- 17-- 1c+3c LHA ; 1W+2c & 1M+4c RHA
- 25-- 1c pass Lsh into ½ Reel4 across with 3c (3c to 2pl), at end 1c turn RH to 3plx RHJ **while{2}** 4c set advancing to join in | 1c+4c ½ RHA (2,3,4,1)

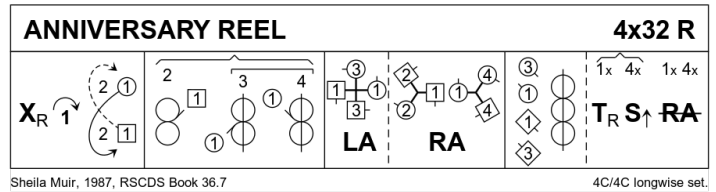

## 8 IAN POWRIE'S FAREWELL TO AUCHTERARDER J128 · 4S

Bill Hamilton: Thirty Popular Dances, Volume Two · Crib: E-cribs · Diagram: Keith Rose's Diagrams

- 1-- Circle8 L and back
- 9-- All W pass in front of P, dance behind next M ; RHA in the centre
- 17-- All W cross in front of opposite M, dance behind next M ; RHA, joining P for
- 25-- All Promenade once round clw (but see note)
- 33-- 1c+3c (W following M) dance on 1 place clw and in (M round M, W round W) to face next couple ; set to and turn that person RH
- 41-- Reels4 across
- 49-- Fig8, 1c round 2c, 3c round 4c
- 57-- 1c+3c LHA ; 1c/3c dance out Lsh round 2c/4c (M round M, W round W) and cclw to places
- 65--96 2c+4c repeat bars 33-64
- 97-- All Promenade once round cclw
- 105-120 The Men repeat [9-24] cclw with LHA in the centre
- 121-- Circle8 RIGHT and back (see note)

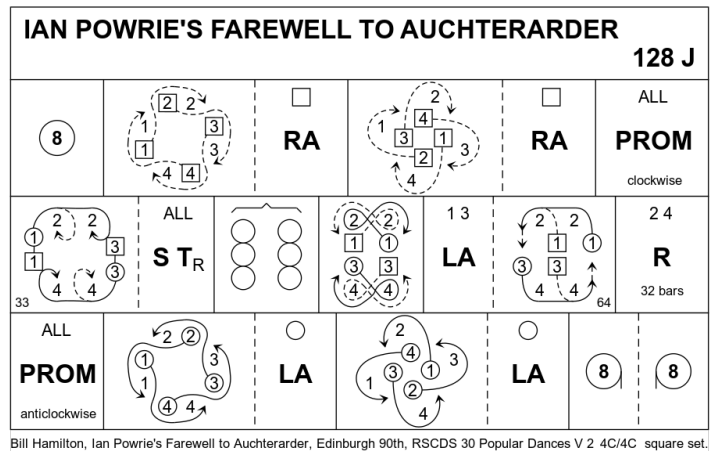

Note: This crib follows the current way of dancing. In the original instructions, the promenade [25-32] is cclw. Bill Hamilton said in 'hindsight' this promenade should be clw, but preferred not to change the official instructions. Bill disapproved of another variant, where the circle [121-128] is continued to the R only.

## 9 SOUTH FROM OBAN J40 · 3/4L

Shirley M Shields: Leeds Branch Tenth Anniversary Book · Crib: MiniCribs · Diagram: Keith Rose's Diagrams

- 1-8 1L+2L lead thru partners, cast back to place & pass RSh to change places & cross RH with opposite partner
- 9-16 1M+2M repeat (2s at top)
- 17-24 2s+1s dance RH across, 1s lead up & cast **while** 2s cast & lead up
- 25-32 1s+3s dance LH across, 1s cast & lead up **while** 3s lead up & cast
- 33-40 2s+1s+3s dance reel of 3 on sides (1s dancing out & up to begin)

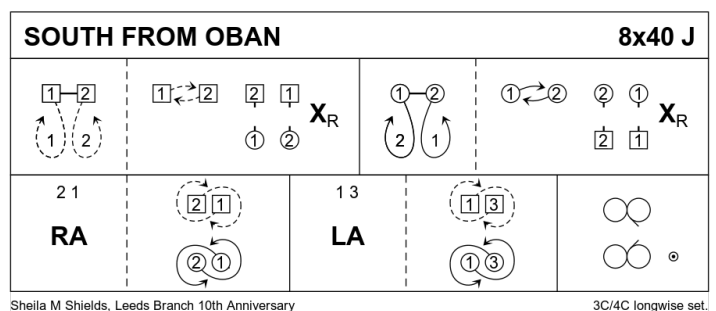

## 10 SCOTT MEIKLE R32 · 4/4L

Alice McLean: RSCDS XLVI 3 · Crib: E-cribs · Diagram: Keith Rose's Diagrams

- 1- 1c cross RH | cast (2c up) ; ½ Fig8 up (2,1,3,4)
- 9- 1c+3c RHA, LHA (2,1,3,4)
- 17- Lsh opposing Reels3 across: (1W+3W behind dancing as one) with 2c and (3M+1M behind) with 4c (to 2,3,1,4)
- 25- 1c+4c ½ R&L ; turn RH 1½ (2,3,4,1)

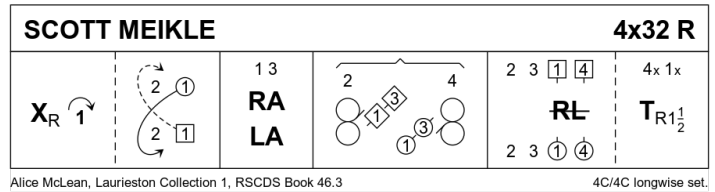

## 11 THE ROSE OF THE NORTH S32 · 3/4L

Roy Goldring: Silver Jubilee 25 - Leeds Branch · Crib: E-cribs · Diagram: Keith Rose's Diagrams

- 1-4 1c lead down, cross below 3c and cast up into 2plx (2c up)
- 5-16 2c+1c+3c R&L for 3 couples
- 17- 1c set to and turn corners, to finish BtoB in the centre, 1M facing up, 1W facing down
- 25- 1M+2c & 1W+3c Circle3 L (at end 1c pull Rsh back to face P) ; 1c set, petronella to 2pl (2,1,3)

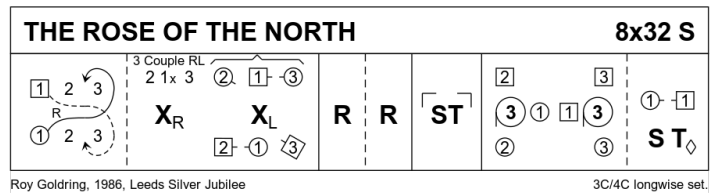

## 12 FATHER CONNELLY'S JIG J64 · 4/4L

John Drewry: The Donside Book · Crib: E-cribs · Diagram: Keith Rose's Diagrams

- 1- 1c+2c Set&Rotate (All set | petronella clw one place ; change places RH with P | chase one place clw) (2,1,3,4)
- 9- ½ diagonal R&L with 1cnrs (W up, M down) **while{4}** the 2cnrs (2M+3W) set & cross RH, all cnrs face out ; ½ Reels3 on the sides, 1c Rsh to 2cnr pos. (no loops at the end) (2x,1x,3x,4)
- 17- Repeat figure from these positions with 2cnr persons (in 3cnr positions ; M up, W down) (to 2,1,3,4), 2c+3c finishing with loops into
- 25- Reels3 across (Lsh to 1cnr) (2,1,3,4)
- 33- 1c cross down RH between 3c | cast Rsh round new 1cnr (4W resp. 3M) ; change places up/dn LH | cast L (3c up) to (2,3,1,4)
- 41-56 3c+1c+4c repeat the figures [9-24] above (2,3,1,4)
- 57- 3c+1c+4c Circle6 and back (optional: 2c join in for Circle8 and back) (1c step down, to 2,3,4,1)

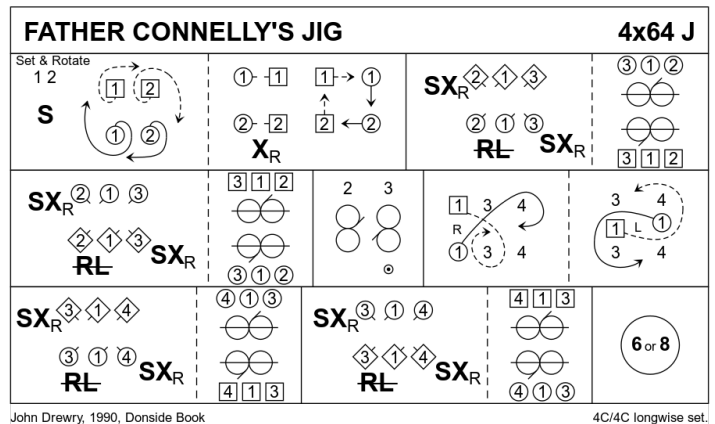

(note by Drewry: This is really two successive 3c dances of 32 bars, the figures of bars 9-24 being similar.)

# 13 THE HIGHLAND RAMBLER R40 · 3/4L

Roy Goldring: *Thirty Popular Dances, Volume Two* · Crib: *E-cribs* · Diagram: *Keith Rose's Diagrams*

- 1-- 1c long cast to 2pl (2c up on [3-4] ; 1c+3c RHA (2,1,3)
- 9-- 2c+1c LHA, 1W faces out ; 1W followed by 1M cast up round 2W and down the middle of set, 1W between 3c and 1M between 2c, all facing down
- 17-- In lines of 3 down the middle (all swivel R) and up
- 25-- 1M followed by 1W dance up, cast round 2W and into 2pl ; 1c turn RH
- 33-- Circle6 and back

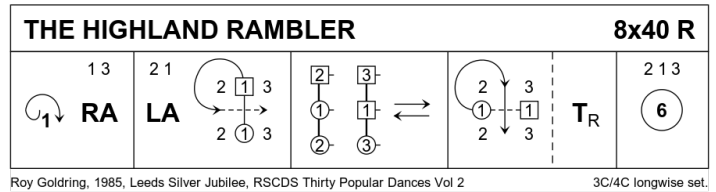

# 14 JACQUI WATSON'S STRATHSPEY S32 · 3/3L

Noel Watson: *The Leeds Golden Collection* · Crib: *E-cribs* · Diagram: *Keith Rose's Diagrams*

- 1-- All set | 1c+2c ½ RHA as 3c cross RH ; All chase clw half round (3,1,2)
- 9-- Reels3 across, 1c Rsh to 2cnr (pos), 1c finish at top NHJ and 3c in 2pl
- 17-- Mirror Reels3 on own side, 3c start in and down, touch hands when possible (1,3,2)
- 25-- Set&Rotate for 3 (2,3,1) [All set | all cast ¼ round clw ; all cross RH with opposite | all chase ¼ clw]

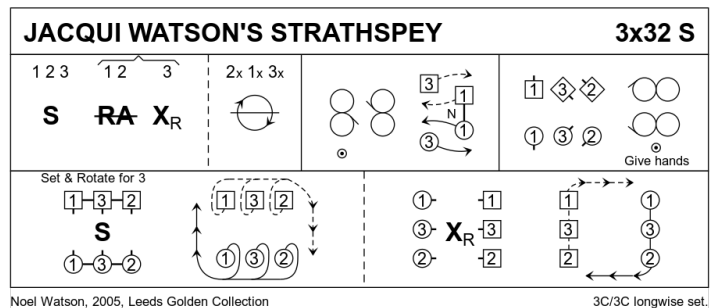

# 15 THE AVIATOR J32 · 3/4L

Carola Fischer: *RSCDS LII 9* · Crib: *E-cribs* · Diagram: *Keith Rose's Diagrams*

- 1-- 1c lead down (2c up), on [4] 1W crosses in front and, 1M following, casts up (round any standing M), to finish 1c in 2pl facing 3W
- 9-- 3W+1c+2M Rsh lead-change diag. Reel3 ; 1M dancing the full reel, **while for [13-16]** 1W turns 3M LH to finish behind 1M, both on midline facing up
- 17-- 2W+1c+3M Rsh lead-change diag. Reel3 ; 1W dancing the full reel, **while for [21-24]** 1M turns 3W LH to finish 1c in 2plx, 1W facing out
- 25-- 1c dance up (1W Rsh to 2M, 1M Rsh to 2W) | 1c dance Rsh round 2W to 2pl | All set.

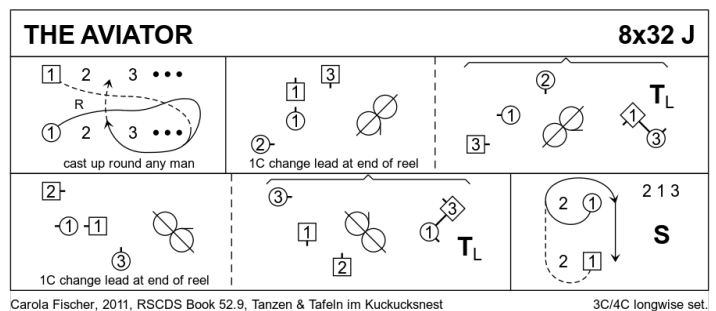

# 16 THE DEIL AMANG THE TAILORS

R32 · 3/4L

RSCDS XIV 7 · Crib: E-cribs · Diagram: Keith Rose's Diagrams

- 1- 1c+2c set, ½ RHA ; set, ½ LHA
- 9- 1c lead down the middle and up, 2c step in for
- 17- 1c+2c Allemande
- 25- 2c+1c+3c circle6 and back.

